

疊加型附止回節流閥

Modular Throttle and Check Valves

系列號 Series No.	規格 Valve Size	最大壓力 Max. Operating Pressure (MPa)	啟動壓力 Checking Pressure (MPa)	最大流量 Max. Flow (L/min)
MPA/B/W-01-*	01	31.5	2: 0.2 4: 0.4	35
MPA/B/W-03-*	03	25		70

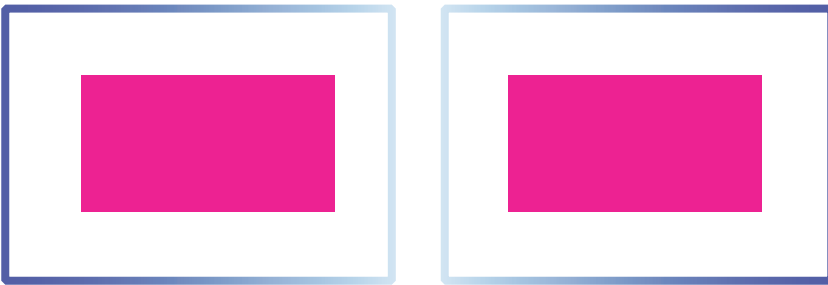
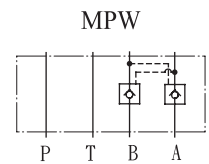
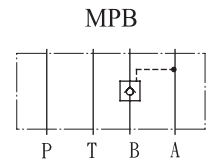
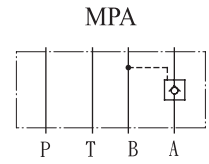

MPA-03 MPB-03 MPW-03

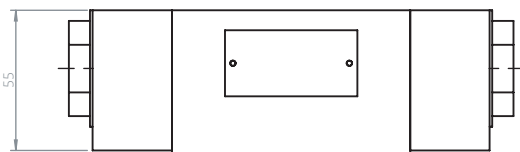
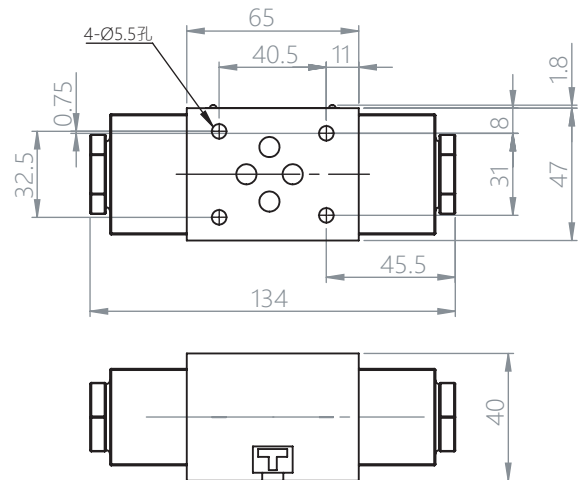
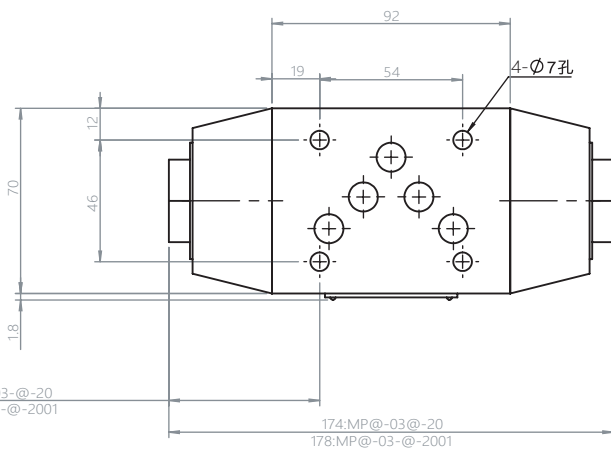

型號	L1	L2
MPA/MPB/MPW-01-@-40	134	45.5
MPA-01-@-4001	138	49.5
MPB-01-@-4001	138	45.5
MPW-01-@-4001	142	49.5